

Cable entry plates

Fast and easy
assembly

Dual sealing
according to IP65/66

UL94 V0 self-extinguishing
options available



MC (IP66/67) cable entry plates are designed to route and seal cables without connectors. They offer quick and easy assembly by creating a small hole in the thin membrane and pushing the cables through. These plates are suitable for standard cut-outs for FL21 and can be securely screwed in place.

Advantages

- Fast and easy assembly
- High cable density
- Dual cable sealing with IP66/IP67
- Excellent IP protection when cables are bent
- Screw mounting
- Suitable for both indoor and outdoor use

Technical specifications

- IP rating: IP66 and IP67
- Material: Thermoplastic elastomer
- Material base frame: Metal reinforcement electroplated steel
- Color: Black or Grey (RAL7035)
- Flame class: UL94-V0, self-extinguishing option available
- Temperature: -40 °C...+100 °C
- Properties: Halogen free, Silicone free
- Mounting type: Screw type mounting
- Diam. of screw holes: 9,5 mm



Description	Package (pcs)	MC 3/7 (IP66/67)	MC 25/27 (IP66/67)	MC 35/37 (IP66/67)
Light Grey RAL 7035 4 plastic pins included	40	MBA1C07G11	MBA1C27G11	MBA1C37G11
Light Grey RAL 7035 UL 94 V-0 approved	60	MBA1N07X11	MBA1N27X11	MBA1N37X11
Black UL 94 V-0 approved	60	MBA1N07B11	MBA1N27B11	MBA1N37B11

Technical data

Service temperature	-40 to + 100 °C	-40 to + 100 °C	-40 to + 100 °C
Dimensions height C (mm)	76	43	43
Number of cables (pcs) x cable diameter (mm)	4 x 8 - 16 2 x 24 - 54 1 x 30 - 60 - -	4 x 5 - 7 4 x 8 - 12 13 x 10 - 14 4 x 14 - 20 2 x 20 - 26	4 x 6 - 10 14 x 8 - 12 16 x 10 - 14 2 x 12 - 18 1 x 17 - 32
Total number of cables	7	27	37
Mounting hole size	C - FL 21	C - FL 21	C - FL 21
Weight (g)	206	229	233

Mounting pins are available on request.

Look more about materials at Comparison of materials on page 148.

Dimensions of cable entry plates and mounting hole

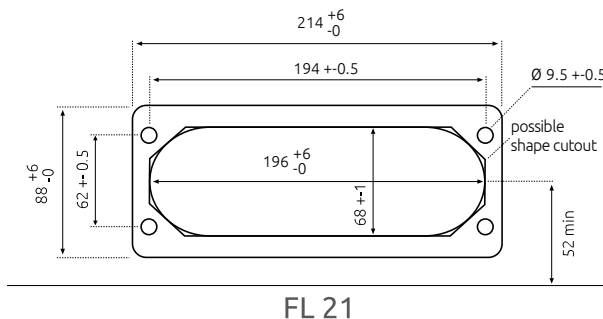
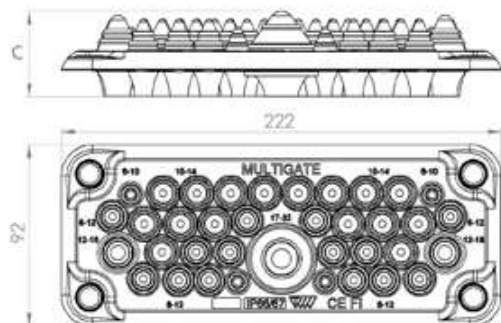

MC (IP65) cable entry plates are designed to route and seal cables without connectors. Assembly is quick and easy by creating a small hole in the thin membrane and pushing the cables through. They are suitable for standard FL21 cut-outs and can be securely screwed in place.

Advantages

- Fast and easy assembly
- High cable density
- Dual cable sealing with IP65
- Hygienic design - free of dirt-collecting recesses
- Screw mounting
- Suitable for both indoor and outdoor use

Technical specifications

- IP rating: IP65
- Material: Thermoplastic elastomer
- Material base frame: Metal reinforcement electroplated steel
- Color: Black or Grey (RAL7035)
- Flame class: UL94-V0, self-extinguishing option available
- Oil-resistant option available
- Temperature: -40 °C...+100 °C
- Properties: Halogen free, Silicone free
- Mounting type: Screw type mounting
- Diam. of screw holes: 9,5 mm



MC 3 (IP65)



MC 25 (IP65)

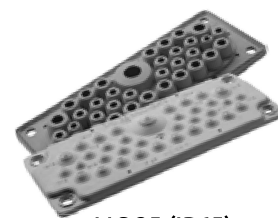

MC 35 (IP65)

Light Grey RAL 7035 4 plastic pins included	● MBA1C03L11	MBA1C25L11	MBA1C35L11
Black	● MBA1N03A11	MBA1N25A11	MBA1N35A11
Black, UL94 V0, oil-resistant	● MBA1N03B11	MBA1N25B11	MBA1N35B11

Technical data

Service temperature	-40 to + 100° C	-40 to + 100° C	-40 to + 100° C
Dimensions (mm)	214 x 82	216 x 84	216 x 84
Number of cables (pcs) x cable diameter (mm)	4 x 8 - 12 (IP54) 2 x 24 - 54 (IP65) 1 x 30 - 60 (IP65) - -	4 x 5 - 7 4 x 8 - 12 12 x 10 - 14 4 x 14 - 20 1 x 20 - 26	2 x 6 - 10 14 x 7 - 12 16 x 10 - 14 2 x 12 - 18 1 x 17 - 32
Total number of cables	7	25	35
Mounting hole size	C - FL 21	C - FL 21	C - FL 21
Weight (g)	199	230	220
Package (pcs)	100	100	100

Mounting pins are available on request.

Look more about materials at Comparison of materials on page 148.

Dimensions of cable entry plates and mounting hole

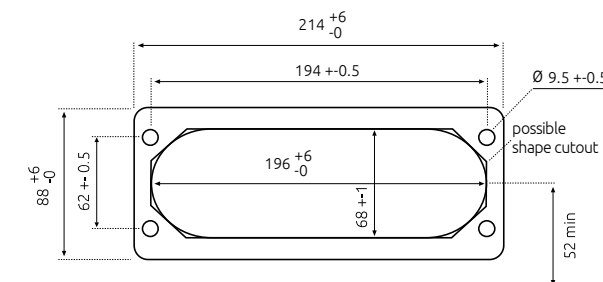
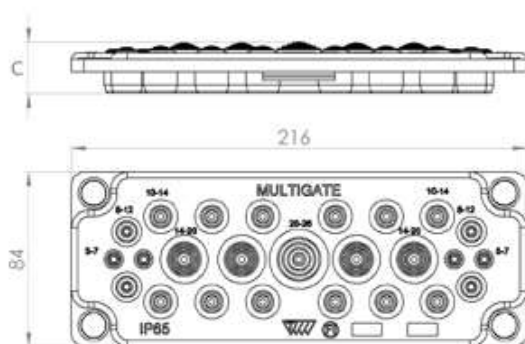

FL 21

MC 4 (IP65)

- MC 4 (IP65) cable entry plates are designed for route and seal cables without connectors
- The assembly of the MC 4 (IP65) with cables or pneumatic hoses can be done quick and easy. Simply make a small hole in the thin membrane and push the cables through

Advantages

- Fast and easy assembly
- High cable density
- Dual cable sealing with IP65
- Hygienic design - free of dirt-collecting recesses
- Screw mounting
- Suitable for both indoor and outdoor use

Technical specifications

- IP rating: IP65
- Material: Thermoplastic elastomer
- Material base frame: Metal reinforcement stainless steel
- Color: Black
- Flame class: UL94-V0, self-extinguishing option available

Stainless steel reinforcement frame eliminates the inductive eddy currents that can be generated by the cables



- Oil-resistant option available
- Temperature: -40 °C...+100 °C
- Properties: Halogen free, Silicone free
- Mounting type: Screw type mounting
- Diam. of screw holes: 9,5 mm



MC 4 (IP65)

Black, UL 94 V-0 approved	●	MBA1F04B11
Technical data		
Service temperature	-40 to + 100° C	
Number of cables (pcs) x cable diameter (mm)	4 x 30 - 63 mm	
Total number of cables	4	
Mounting hole size	283 x 68 mm	
Weight (g)	258	
Package (pcs)	50	

Look more about materials at Comparison of materials on page 148.

Dimensions of cable entry plates and mounting hole

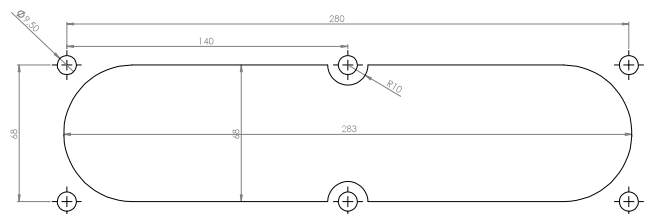
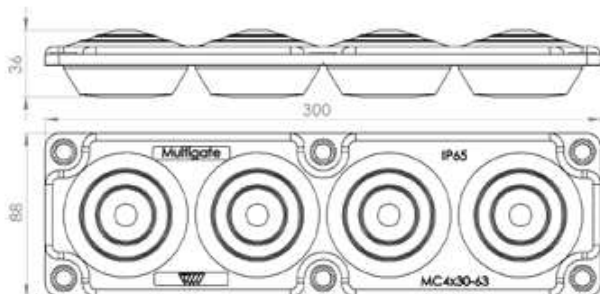

- MC 10 (IP55) cable entry plates are designed for route and seal cables without connectors
- The assembly of the MC 10 (IP55) with cables or pneumatic hoses can be done quick and easy. Simply make a small hole in the thin membrane and push the cables through
- Suitable for standard cut-outs for FL21. For screwing in place

Advantages

- Fast and easy assembly
- High cable density
- Excellent IP protection when cables are bent
- Screw mounting
- Suitable for both indoor and outdoor use

Technical specifications

- IP rating: IP55
- Material: Thermoplastic elastomer (TPE)
- Material base frame: glass fibre reinforced polypropylene (PP-GF)
- Color: Grey (RAL7035)
- Temperature: -40 °C...+100 °C
- Properties: Halogen free, Silicone free
- Mounting type: Screw type mounting
- Diam. of screw holes: 9,5 mm



MC 10 (IP55)

Light Grey, RAL 7035 UL 94 V-0 approved	●	MBA1N10X11
Technical data		
Service temperature	-40 to + 100 °C	
Number of cables (pcs) x cable diameter (mm)	2 x 7 - 12 8 x 10 - 30	
Total number of cables	10	
Mounting hole size	C - FL 21	
Weight (g)	200	
Package (pcs)	100	

Mounting pins are available on request.
Look more about materials at Comparison of materials on page 148.

Dimensions of cable entry plates and mounting hole

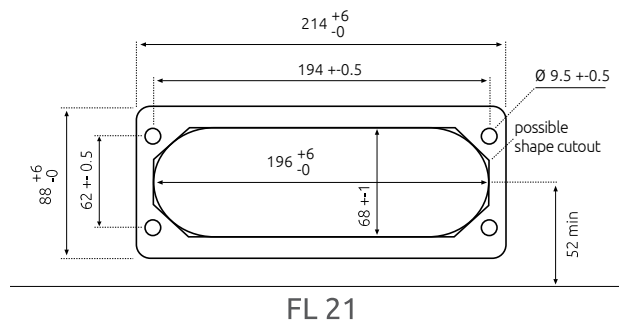
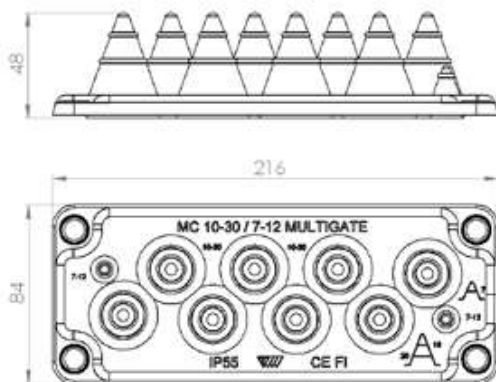

- LMC (IP44, 54) cable entry plates are designed for route and seal cables without connectors
- The assembly of the LMC (IP44, 54) with cables or pneumatic hoses can be done quick and easy. Simply make a small hole in the thin membrane and push the cables through
- Suitable for standard cut-outs for FL21. For screwing in place

Advantages

- Fast and easy assembly
- High cable density
- Excellent IP protection when cables are bent
- Screw mounting
- Suitable for both indoor and outdoor use

Technical specifications

- IP rating: IP44, IP54
- Material: Thermoplastic elastomer
- Material base frame: Metal reinforcement electroplated steel
- Color: Grey (RAL7035)
- Flame class: UL94-V0, self-extinguishing option available
- Temperature: -40 °C...+90 °C
- Properties: Halogen free, Silicone free
- Mounting type: Screw type mounting
- Diam. of screw holes: 9,5 mm



LMC 14 (IP54)

LMC 25 (IP54)

LMC 51 (IP55)

LMC 35 (IP44)

Light Grey RAL 7035 Bulk packaging without pins	● MBA3N14L11	MBA3N25L11	MBA3N51L11	MBA3N35L11
Light Grey RAL 7035 Single packaging with pins	● MBA3C14L11	MBA3C25L11	MBA3C51L11	MBA3C35L11
Light Grey RAL 7035 UL 94 V-0 approved	● MBA3N14X11	MBA3N25X11	MBA3N51X11	-

Technical data

Service temperature	-40 to + 100 °C	-40 to + 100 °C	-40 to + 100 °C	-40 to + 100 °C
Number of cables (pcs) x cable diameter (mm)	5 x 10 - 14 4 x 14 - 18 3 x 14 - 22 2 x 24 - 54 -	2 x 3.5 - 11 5 x 10 - 14 12 x 14 - 18 5 x 14 - 22 1 x 14 - 35	50 x 7 - 13 1 x 15 - 25 - - -	1 x 15 - 32 2 x 12 - 18 16 x 10 - 14 14 x 7 - 12 2 x 6 - 10
Total number of cables	14	25	51	35
Mounting hole size	C - FL 21	C - FL 21	C - FL 21	C - FL 21
Weight (g)	199	201	205	220
Package (pcs)	100	100	100	100
Width (B) / Height (C) / Length (A) (mm)	222 / 92 / 30	222 / 92 / 30	222 / 92 / 30	214 / 84 / 9,5

Mounting pins are available on request. Look more about materials at Comparison of materials on page 148.

Pin (4 pcs)

Product code

MBA7300G11



Dimensions of cable entry plates and mounting hole

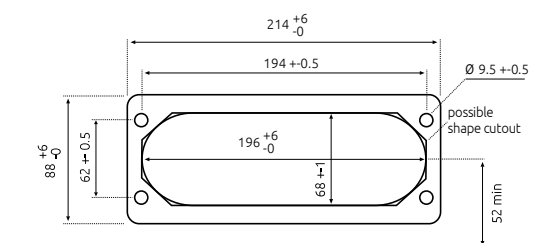
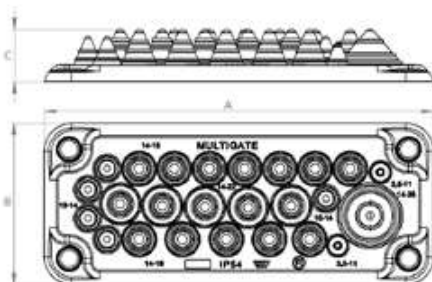

- MC 16 (IP54) cable entry plates are designed for route and seal cables without connectors
- The assembly of the MC 16 (IP54) with cables or pneumatic hoses can be done quick and easy. Simply make a small hole in the thin membrane and push the cables through
- MC 16 can be used by two different ways. When the cable entry plate is used "facade" up, it works as a regular IP54 enclosure cable gland plate. When the cable entry plate is used reversed it functions as a piping grommet in dry space switchboards. Pipes lock securely to the seal in the gland plate by the friction of the elastic material
- Suitable for standard cut-outs for FL21. For screwing in place

Advantages

- Fast and easy assembly
- High cable density
- Excellent IP protection when cables are bent
- Screw mounting
- Suitable for both indoor and outdoor use

Technical specifications

- IP rating: IP55
- Material: Thermoplastic elastomer (TPE)
- Material base frame: glass fibre reinforced polypropylene (PP-GF)
- Color: Grey (RAL7035)
- Temperature: -40°C...+100°C
- Properties: Halogen free, Silicone free
- Mounting type: Screw type mounting
- Diam. of screw holes: 9,5 mm



MC 16 (IP54)

Light Grey, RAL 7035 4 plastic pins included	●	MBA1C16L11
Technical data		
Service temperature	-40 to + 100 °C	
Number of cables (pcs) x cable diameter (mm)	15 x 10 - 20 1 x 10 - 30	
Total number of cables	16	
Mounting hole size	C - FL 21	
Weight (g)	120	
Package (pcs)	80	

Mounting pins are available on request.
Look more about materials at Comparison of materials on page 148.

Dimensions of cable entry plates and mounting hole

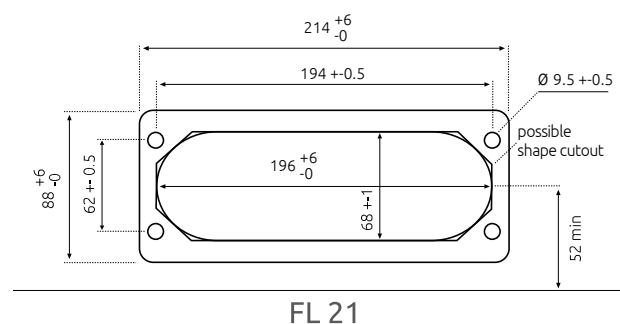
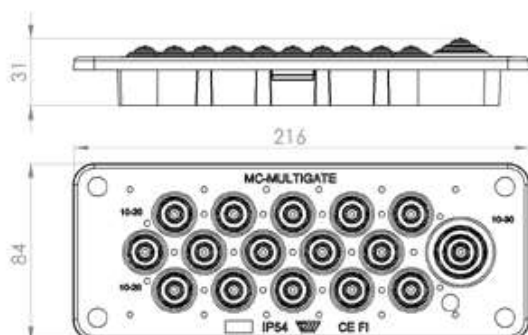

- MB (IP55, 66/67) cable entry plates are designed for route and seal cables without connectors
- The assembly of the MB (IP55, 66/67) with cables or pneumatic hoses can be done quick and easy. Simply make a small hole in the thin membrane and push the cables through
- Suitable for standard cut-outs for FL13. For screwing in place

Advantages

- Fast and easy assembly
- High cable density
- Dual cable sealing with IP66/IP67
- Excellent IP protection when cables are bent
- Screw mounting
- Suitable for both indoor and outdoor use

Technical specifications

- IP rating: IP55, IP66 and IP67
- Material: Thermoplastic elastomer
- Material base frame: Metal reinforcement electroplated steel
- Color: White or Grey (RAL7035)
- Flame class: UL94-V0, self-extinguishing option available
- Temperature: -40°C...+100 °C
- Properties: Halogen free, Silicone free
- Mounting type: Screw type mounting
- Diam. of screw holes: 7 mm



MB 4/10 (IP55)*



MB 5/11 (IP66/67)*

Light Grey RAL 7035	●	-	MBA2N11L11
Light Grey RAL 7035 UL 94 V-0 approved	●	MBA2N10W11	MBA2N11X11
White UL 94 V-0 approved	○	MBA2N12W11	-

Technical data

Service temperature	-40 to + 100 °C	-40 to + 100 °C
Number of cables (pcs) x cable diameter (mm)	4 x 10 - 25 6 x 4 - 9 - -	4 x 5 - 7 3 x 7 - 10 2 x 10 - 14 2 x 15 - 30
Total number of cables	10	11
Mounting hole size	B - FL 13	B - FL 13
Weight (g)	68	86
Package (pcs)	200	200

* For the smaller mounting hole (size B).
Look more about materials at Comparison of materials on page 148.

Dimensions of cable entry plates and mounting hole

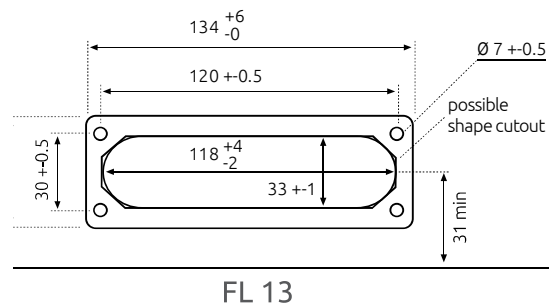
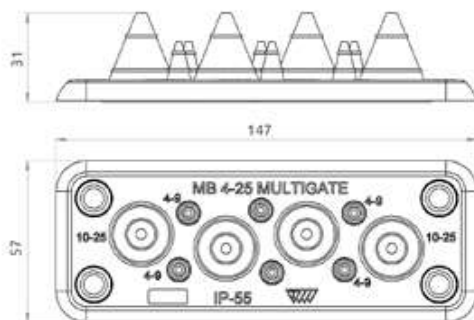

Type	Length (A)	Width (B)	Height (C)
MB (IP55, 66/67)			
MB 4/10 (IP55)	146	56	31
MB 5/11 (IP66/67)	147	57	42

MHF series plastic reinforced cable entry plates are suitable for leading through cables and various types of tubing. They match the cut-out dimensions of standard 10/16/24-pole industrial connectors, no separate gaskets are needed. These cable entry plates give total protection against ingress of dust and water splashed from all directions, due to IP protection class of IP66 and are suitable for both indoor and outdoor use. The materials are self-extinguishing (UL94 V0) and halogen free, the outer sides of the cable entry plates are flat, and thus suitable for medical and food industries, due to ease of cleaning.











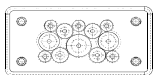

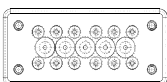

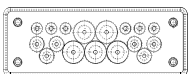

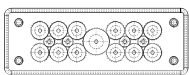

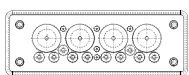

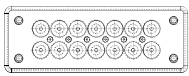
Technical specifications

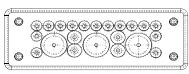

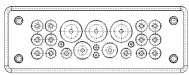
- IP rating: IP66
- Membrane material: Thermoplastic elastomer
- Frame material: Glass fiber reinforced polypropylene
- Color: Grey (RAL7035) or black (RAL9005)
- Flame-retardancy class: UL94 V0
- Temperature: -40 °C...+90 °C
- Properties: Halogen free, Silicone free
- Mounting type: Screw type mounting
- Diam. of screw holes: 4,2 mm

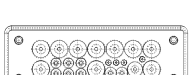
Advantages

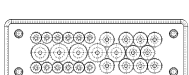
- High cable density
- Self-extinguishing plastic
- Dual cable sealing with IP66
- Hygienic design - free of dirt-collecting recesses
- Screw mounting
- Suitable for both indoor and outdoor use

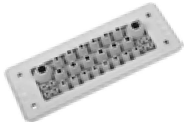
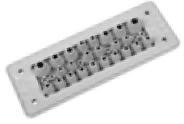
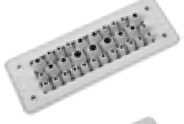

Drawing	Name	Product code	No. of cables x diameter	Weight (g)	Opening size
		MH10 F12-1 ● MBA8N12X10 ● MBA8N12B10	5 x 3 - 7 4 x 5 - 10 2 x 7 - 13 1 x 9 - 16	48	B10
		MH16 F17-1 ● MBA8N17X16 ● MBA8N17B16	12 x 3 - 7 5 x 7 - 13	59	B16
		MH24 F17-2 ● MBA8N17X24 ● MBA8N17B24	6 x 3 - 7 6 x 5 - 10 5 x 9 - 16	64	B24
		MH24 F17-3 ● MBA8N17X10 ● MBA8N17B10	4 x 3 - 7 12 x 7 - 20 1 x 10 - 20	59	B24
		MH24 F19-1 ● MBA8N19X24 ● MBA8N19B24	5 x 1,5 - 3 10 x 3,2 - 6,5 4 x 16 - 22	71	B24
		MH24 F20-1 ● MBA8N20X24 ● MBA8N20B24	6 x 1,5 - 3 14 x 7,2 - 12	71	B24
		MH24 F22-1 ● MBA8N22X24 ● MBA8N22B24	15 x 3 - 7 4 x 4,5 - 10 3 x 15 - 20"	65	B24
		MH24 F23-1 ● MBA8N23X24 ● MBA8N23B24	4 x 1,5 - 3 4 x 3,2 - 6,3 10 x 4 - 7,5 1 x 5,5 - 10,5 1 x 8 - 12,5 3 x 12 - 16,2"	71	B24
		MH24 F23-2 ● MBA8N24X24 ● MBA8N24B24	4 x 1,5 - 3 6 x 3,2 - 6,3 2 x 4 - 7,5 1 x 5,5 - 10,5 10 x 8 - 12,5	71	B24
		MH24 F27-1 ● MBA8N27X24 ● MBA8N27B24	12 x 3 - 7 10 x 4,5 - 10 5 x 7 - 13	70	B24
		MH24 F30-1 ● MBA8N30X10 ● MBA8N30B10	30 x 3 - 8	71	B24

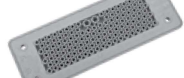
Drawing	Name	Product code	No. of cables x diameter	Weight (g)	Opening size
	MH24 F30-2	<ul style="list-style-type: none"> ● MBA8N30X24 ● MBA8N30B24 	8 x 1,5 - 3 8 x 3,2 - 5,5 6 x 4 - 7,5 6 x 5 - 8,5 2 x 9,5 - 14,5	71	B24
	MH24 F30-3	<ul style="list-style-type: none"> ● MBA8N32X24 ● MBA8N32B24 	6 x 1,5 - 3 4 x 3,2 - 6,3 14 x 4 - 7,5 2 x 8 - 12,5	71	B24
	MH24 F31-1	<ul style="list-style-type: none"> ● MBA8N31X24 ● MBA8N31B24 	20 x 3,2 - 6,5 8 x 5 - 10,2 3 x 7,5 - 12	71	B24
	MH24 F42-1	<ul style="list-style-type: none"> ● MBA8N42X24 ● MBA8N42B24 	42 x 3,2 - 6,5	71	B24
	MH24 F125-1	<ul style="list-style-type: none"> ● MBA8N125X24 ● MBA8N125B24 	123 x 1,5 - 3 2 x 2,5 - 5	71	B24

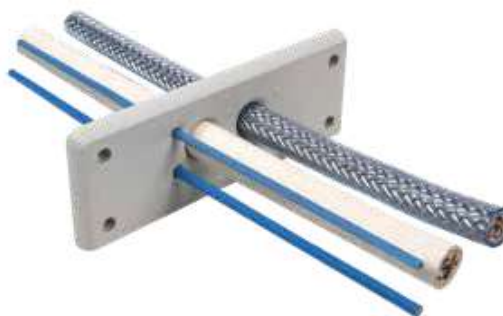

Dimensions

MH10

MH16

MH24

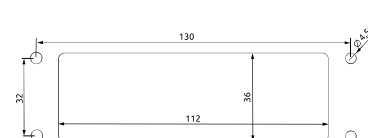
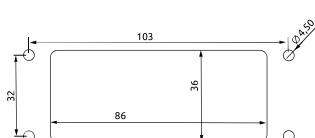
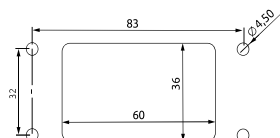
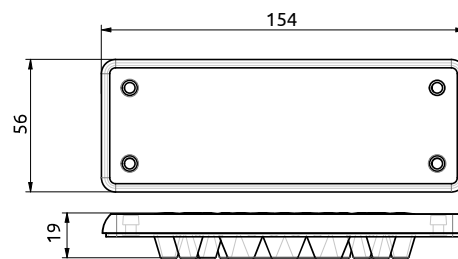
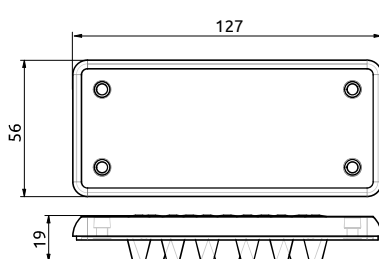
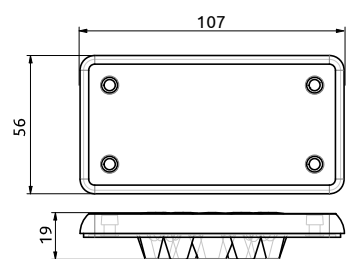

Cable/tube diameter	MH-10 F12-1	MH-16 F17-1	MH-24 F17-2	MH-24 F17-3	MH-24 F22-1	MH-24 F27-1	MH-24 F30-1	MH-24 F19-1	MH-24 F20-1	MH-24 F23-1	MH-24 F23-2	MH-24 F30-2	MH-24 F30-3	MH-24 F31-1	MH-24 F42-1	MH24 F125-1
1.5-3mm								5	6	4	4	8	6			123
2.5-5mm																2
3-7mm	5	12	6	4	15	12										
3-8mm							30									
3.2-5.5mm												8				
3.2-6.3mm										4	6		4			
3.2-6.5mm								10						20	42	
4-7.5mm										10	2	6	14			
4.5-10mm					4	10										
5-8.5mm												6				
5-10mm	4		6													
5-10.2mm														8		
5.5-10.5mm										1	1					
7-13mm	2	5				5										
7-20mm				12												
7.2-12mm									14							
7.5-12mm														3		
8-12.5mm										1	10		2			
9-16mm	1		5													
9.5-14.5mm												2				
10-20mm				1												
12-16.2mm										3						
15-20mm					3											
16-22mm								4								

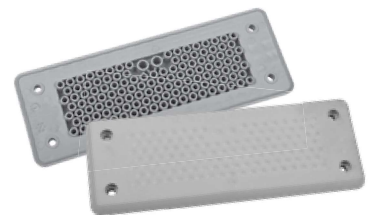

Cable entry plate RMC (IP65)

Patent-pending solution

Very quick, precise and easy way to insert cables

No need to use cutting, pliers, knives or other tools



- Cable gland plate used as a conductor entry point in an electrical cabinet; the enclosure wall thickness can vary from 1 to 4 mm
- For use with diverse cable sizes in both low and medium voltage power applications
- Suitable for rough industrial conditions indoors as well as extreme climatic conditions outdoors

Advantages

- Each cable entry point has a tab that can be peeled off to create an opening for quick insertion and pull-through operations without the need for cutting pliers, knives or other tools
- Pre-embossed, circular entry points guarantee a precise, clean and robust seal around the cable; no additional glands or gaskets required
- A high density of incoming/outgoing conductors can be installed with minimal space requirements

Technical specifications

- Feed-through membrane made of thermoplastic elastomer (TPE) with polypropylene glass fiber reinforcement (PP-GF)
- Cable entry points with various cross-sectional diameters (no pre-attached connectors)
- Available in two colors: black and light grey (RAL7035)
- Designed to match an FL21 flange size cut-out
- Standard M8 bolts used for mounting on the enclosure wall (bolts not included in package)
- High IP65 protection against the ingress of dust and water
- Flammability rating according to UL 94 V-0
- Operational ambient temperature range (material unstressed): -40 °C...+90 °C

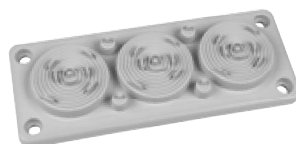

RMC 3 (IP65)



RMC 17 (IP65)

Grey (RAL 7035)	●	MBA9N07X11	MBA1N17X11
Black (RAL 9005)	●	MBA9N07B11	MBA1N17B11

Technical data

Number of cables (pcs) x cable diameter (mm)	4 x 7-10 3 x 12-57	4 x 5-7 2 x 10-12 2 x 12-15 9 x 10-30
Total number of cables	7	17
Dimensions A / B / C (mm)	220 / 88 / 25,5	220 / 88 / 25,5
Classification	UL 94 V-0	UL 94 V-0
Weight (g)	131	134
Package (pcs)	100	100

Look more about materials at Comparison of materials on page 148.

Dimensions

RMC 3

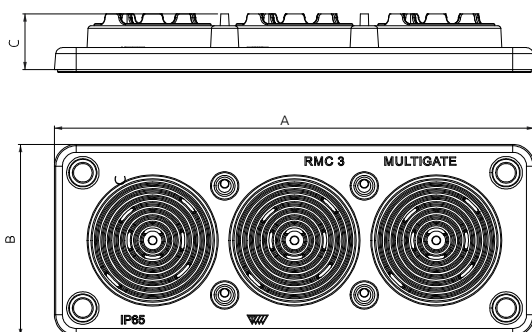

RMC 17

